



Global Data Transmitter Single Prime Plus GPRS/UMTS

User manual (original instructions)



Meet the difference

Contents

| | | |
|-------|---|----|
| 1 | Introduction | 4 |
| 1.1 | How to use this manual | 4 |
| 1.2 | Original instructions | 4 |
| 1.3 | Working principle | 4 |
| 1.3.1 | Eijkelkamp Smart Sensoring | 4 |
| 1.3.2 | Data communication overview | 4 |
| 1.3.3 | Communication intervals | 5 |
| 1.3.4 | Modem | 6 |
| 1.3.5 | GDT Server | 6 |
| 1.3.6 | Eijkelkamp Web Portal | 7 |
| 1.3.7 | E-mail functionality | 7 |
| 1.3.8 | API functionality | 7 |
| 1.4 | Service and support | 8 |
| 1.4.1 | Qualified personnel | 8 |
| 1.4.2 | Contact details | 8 |
| 2 | Safety | 9 |
| 2.1 | Symbols in the manual | 9 |
| 2.2 | Intended use | 9 |
| 2.3 | Qualification of the user | 9 |
| 2.4 | Liability | 9 |
| 2.5 | Regulations and instructions | 10 |
| 2.5.1 | Modem | 10 |
| 2.5.2 | Battery | 10 |
| 2.5.3 | Connection | 10 |
| 2.6 | Environment and disposal of waste | 11 |
| 2.6.1 | Correct disposal of the product | 11 |
| 2.6.2 | Correct disposal of the battery | 11 |
| 3 | Product overview | 12 |
| 3.1 | Outside view | 12 |
| 3.2 | Inside view | 13 |
| 3.3 | Explanation of the controls | 13 |
| 3.3.1 | Start switch | 14 |
| 3.3.2 | Connection / Error LED (green / red) | 14 |
| 3.4 | Technical data | 15 |
| 3.4.1 | Mechanical specifications | 15 |
| 3.4.2 | Electrical specifications | 15 |
| 3.4.3 | Connections | 15 |
| 3.4.4 | Ambient conditions | 16 |
| 3.4.5 | Certifications | 16 |
| 4 | Getting started | 17 |
| 4.1 | Unpacking | 17 |
| 4.2 | Providing power for the modem and/or sensor | 17 |
| 4.3 | Setting up first-time communication | 17 |
| 4.3.1 | Placing internal battery | 18 |
| 4.3.2 | Select top port sensor | 18 |
| 4.3.3 | Location | 20 |
| 4.3.4 | Intervals | 20 |
| 4.3.5 | Setting up internal compensation | 21 |
| 4.3.6 | E-mail addresses | 21 |

| | | |
|-------|--|----|
| 4.4 | Installation | 22 |
| 4.4.1 | Mounting the modem | 22 |
| 4.4.2 | Connecting the sensor cable bottom connector | 23 |
| 4.4.3 | Connecting the external power connector..... | 24 |
| 4.4.4 | Connecting the antenna | 24 |
| 4.4.5 | Connecting the sensor cable top connector..... | 25 |
| 4.5 | Commissioning | 25 |
| 4.6 | Connector configuration top port..... | 26 |
| 5 | Maintenance | 28 |
| 5.1 | Preparation | 28 |
| 5.2 | General inspection overview | 28 |
| 5.3 | Inspection and cleaning | 28 |
| 5.3.1 | Inspecting and cleaning the outside of the modem | 28 |
| 5.3.2 | Dismounting the modem | 29 |
| 5.3.3 | Opening the enclosure | 29 |
| 5.3.4 | Inspecting and cleaning the inside of the modem | 29 |
| 5.3.5 | Replacing the desiccant bag | 29 |
| 5.3.6 | Closing the enclosure | 30 |
| 5.3.7 | Mounting the modem | 30 |
| 5.4 | (Re-)placing the battery | 30 |
| 5.5 | (Re-)placing the SIM card (optional) | 31 |
| 5.6 | (Re)placing sensor(s) | 32 |
| 5.7 | Storage | 32 |
| 6 | Specifications | 33 |
| 6.1 | Parts list | 33 |
| 7 | Declaration of Conformity | 34 |
| 7.1 | EC Declaration GPRS | 34 |
| 7.2 | EC Declaration UMTS..... | 35 |

Disclaimer

Nothing from this document may be copied and/or made public by means of printing, photocopy, microfilm or in any other way without the prior written approval of the publisher. Technical data can change without prior notification. Eijkelkamp Soil & Water is not responsible and/or liable for any damage and/or personal injury due to (incorrect) use of this product. Eijkelkamp Soil & Water would be pleased to receive your reactions and comments about this product and the user instructions.

1 Introduction

1.1 How to use this manual

This manual is intended as a reference manual by which users can use and configure the Global Data Transmitter Single Prime Plus GPRS (or Global Data Transmitter Single Prime Plus UMTS), henceforth called the modem. The modem features Global Navigation Satellite System (GNSS) tracing, using the GPS and GLONASS system, henceforth called GPS. Make sure you have read and understood the manual before you use the modem. For an overview of the modem and its components, refer to chapter 3. Make sure that you:

- know the contents of this manual;
- follow up all directions;
- do not change the sequence of the procedures.

1.2 Original instructions

The original instructions for this manual have been written in English. Other language versions of this manual are a translation of the original instructions.

1.3 Working principle

1.3.1 Eijkelkamp Smart Sensing

The purpose of Eijkelkamp Smart Sensing is to collect data of measurements in the field. Eijkelkamp Smart Sensing works by means of a wireless data connection to the GSM network (GPRS or UMTS¹). The data connection is encrypted to prevent unwanted access. Eijkelkamp Smart Sensing consists of sensors, the modem, and the GDT Server. The communication between these devices and their function will be discussed in the following sections.

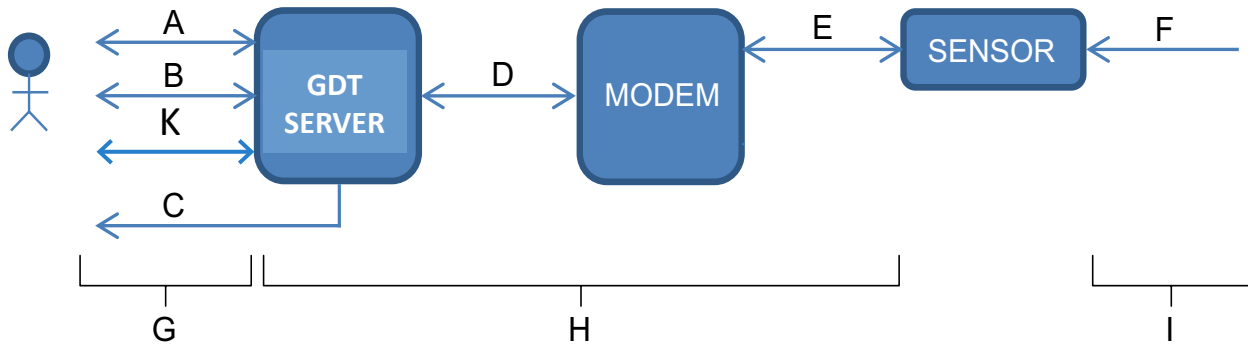

1.3.2 Data communication overview

- A Eijkelkamp Web Portal
- B E-mail
- C SMS alarm
- D GSM Network
- E Sensor cable
- F Sensor measurement
- G User communication
- H Wake-up interval
- I Measurement interval
- K API link

1. UMTS is optional.

| Device / tool | Communication | Activity | Refer to |
|------------------------------------|------------------------------------|---|-----------------------|
| Sensor | Sensor cable | <ul style="list-style-type: none"> perform the measurements store data | |
| Modem | Sensor cable GSM (GPRS or UMTS) | <ul style="list-style-type: none"> intermediates between the GDT Server and the sensor communicates with the GDT Server store data the internal barometer measures the air pressure and temperature | 1.3.4 |
| GDT Server | GSM (GPRS or UMTS) | <ul style="list-style-type: none"> communicates with the modem and its connected sensor(s) collects and stores data configures the modem and sensor settings | 1.3.5 |
| Eijkelpark Web Portal E-mail | Internet | <ul style="list-style-type: none"> user can configure modem and sensor settings receives data from the GDT Server user can view the status of the modem and sensor | 1.3.6 and 1.3.7 |

1.3.3 Communication intervals

The following figure shows an example of how the various communication intervals between the devices can be arranged.

- A Measurement interval of sensor 1
- B Wake-up interval
- C Measurement interval of internal Barometer
- D E-mail send interval



Measurement interval

A measurement interval is the interval between two sensor measurements of a sensor. The measurement interval can be adjusted.

Wake-up interval

The wake-up interval is the frequency in which the modem starts up (wakes up from sleep mode) to intermediate between the GDT Server and the connected sensor (s).



Note

SMS messages are only sent in case of an alarm situation (and hence not in a specific interval).

E-mail send interval

The e-mail send interval is the frequency with which the GDT Server collects any unsent measurement data and sends the new data to the user.



Note

The e-mail send interval only applies to e-mail communication, not to any other user related communication (Eijkelpark Web Portal, API, SMS alarm).

1.3.4 Modem

For an overview of the modem and its components, refer to chapter 3. The modem is the connecting element between the sensor(s) and the GDT Server in Eijkelkamp Smart Sensing. The modem is designed to obtain measurement data from a central location without having to travel to the location(s) where the sensors are placed. The modem will periodically become active at wake-up intervals and log into the GDT Server.

The most important functions of the modem are:

- Transporting sensor data of the connected sensor to the GDT Server;
- Enabling remote monitoring and control of the connected sensor(s).

The most important features of the modem are:

- No software needed;
- Global connectivity;
- Powered with standard alkaline batteries;
- External power supply;
- GPS and GLONASS global positioning data;
- Easy 'plug-and-play' installation;
- Internal barometer;
- Internal logger;
- Real time alarms;
- 2 ports available for sensor connections:
 - Top port supports the following interfaces:
 - Aquaread AP-probe
 - SDI-12
 - Diver or e+ logger
 - Analogue (pulse, voltage or current)
 - Bottom port supports the following interfaces:
 - Diver or e+ logger

There are three methods to get access to the modem. The following table gives an overview.

| Option | Tool | Refer to |
|-----------------------|------------------|--|
| Eijkelkamp Web Portal | Web browser | Online manual on Eijkelkamp Web Portal |
| E-mail functionality | E-mail addresses | Supplement 2 (M-11320102E) |
| API | REST-client | Eijkelkamp Soil & Water |

1.3.5 GDT Server

The GDT Server is designed to control the modem and its connected sensor. The following table gives an overview.

| Type of control | Specification |
|-----------------|--|
| Communication | Collecting data at wake-up intervals |
| Monitoring | Checking the status |
| Configuration | Changing the settings |
| Alarming | Sending an e-mail and/or SMS notification in case the user defined or predefined limits are exceeded. Also signals an alarm in the Eijkelkamp Web Portal |

1.3.6 Eijkelkamp Web Portal

The webportal is designed to give automated access to the GDT Server.

The web portal:

- Gives automated access to the data;
- Has a user-friendly interface to configure the modem and sensor settings.

Requirements:

- Internet access;
- Web browser;
- User account to log into the Eijkelkamp Web Portal.



Note

Refer to the online manual on the Eijkelkamp Web Portal for detailed information on how to use the web portal.

1.3.7 E-mail functionality

The user can receive measurement and configuration data from the modem through e-mail.

The user can communicate with the modem by sending an e-mail to the GDT Server. The e-mail interface is a low level protocol to communicate with the modem.

Requirements:

- Internet
- A user e-mail address
- A modem e-mail address



Note

Refer to Supplement 2 manual for detailed information on how to use the e-mail functionality.

1.3.8 API functionality

The API is designed to give easy access to the GDT Server.

The API:

- Gives quick access to the data;
- Allows configuration of modem and sensor settings.

Requirements:

- Internet access;
- REST-client;
- User account to use the API.



Note

Contact Eijkelkamp Soil & Water for detailed information on how to use the API.

1.4 Service and support

1.4.1 Qualified personnel

Eijkelkamp Soil & Water maintains a staff of experienced service personnel. Their expert knowledge could be of assistance at inspection, installation, or repair activities. For information with respect to specific adjustments, installation, maintenance or repair jobs, which fall beyond the scope of this manual, contact Eijkelkamp Soil & Water.

Make sure you have the following data at hand:

- Product code²
- Date of manufacture
- Serial number
- Date of purchase
- Invoice number

1.4.2 Contact details

The address and contact details can also be found on the front of this manual.

Eijkelkamp Soil & Water BV
Nijverheidsstraat 30
6987 EM Giesbeek
The Netherlands
Telephone +31 313 88 02 00
E-mail info@eijkelkamp.com
Internet www.eijkelkamp.com

2. The product code can be found in the footer of every page. The product code starts with an M.

2 Safety

2.1 Symbols in the manual



WARNING

'Warning' identifies a hazard that could lead to personal injury, including death.



CAUTION

'Caution' identifies a hazard that could lead to damage to the machine, damage to other equipment and/or environmental pollution.



Note

'Note' is used to highlight additional information.

2.2 Intended use

The modem is designed to communicate with a sensor in the field. The modem has 2 sensor ports and a connection for external power supply. The user can configure the modem according to his/her own wishes, for instance regarding wake-up interval.



CAUTION

The modem has class IP68 protection (only with connected connectors). This means the modem is dust protected and resistant against temporary immersion. The temporary immersion must not exceed 50 hours, at a maximum of 2 meter under water. Do not continuously submerge in water. When there is water inside the enclosure, contact Eijkelkamp Soil & Water.



CAUTION

Every other or further use is not in conformance with the intended use.

2.3 Qualification of the user

The user should have a general knowledge about the use of a computer system and computer programs. For the basic maintenance work a general technical background is required.

2.4 Liability

The modem is delivered factory sealed with IP68 protection class (50hrs@2mH₂O).



CAUTION

We prefer not to open the modem in the field. Only open the modem in a clean and dry environment. Avoid unnecessary opening of the modem.

The IP68 protection class can only be preserved and guaranteed when the following parts are clean, dust-free and undamaged:

- enclosure;
- sealing of the enclosure;
- connectors.

Furthermore, make sure that:

- The sensor cable is correctly connected. Refer to 4.4.2 and 4.4.5.
- The modem is mounted correctly in the monitoring well. Refer to 4.4.1.
- The work is performed according to the local ESD safety regulations.
- Only original Eijkelkamp Soil & Water or recommended parts are used.

2.5 Regulations and instructions

2.5.1 Modem



WARNING

- Do not use the modem when it is wet or moisty inside the enclosure.
- Dry a wet or moisty modem with a dry, lint-free cloth. Do not dry the modem in any other way.



Note

Never take a lithium battery or a modem with an installed lithium battery with you as luggage during a flight. Due to severe civil aviation regulations (class 9 dangerous goods), it is forbidden to take a lithium battery with you during a flight. The lithium battery, or modem with lithium battery enclosed, should be officially packaged with the necessary certificates and send by air cargo. Make sure that you comply with the aviation regulations.

2.5.2 Battery

The modem will operate with two Alkaline D-type batteries or with a Lithium DD-type battery, refer to 6.1.

Which type you use depends on your lifetime requirements for the battery.

This lifetime will largely depend on the frequency of the wake-up interval, real time alarm conditions and power usage of the sensor connected to the sensor port 2 (top cap).

The DD-type battery contains Lithium metal. This battery has a high energy density so they must be handled with care. Incorrect usage could lead to overheating and explosion.



WARNING

- Do not use a damaged battery.
- Keep the battery away from fire or heating source.
- Do not submerge the battery in water.
- Always use the correct battery. Only use recommended parts.
- Do not short circuit the battery.
- Do not charge the battery.



Note

Never take a lithium battery or a modem with an installed lithium battery with you as luggage during a flight. Due to severe civil aviation regulations (class 9 dangerous goods), it is forbidden to take a lithium battery with you during a flight. The lithium battery, or modem with lithium battery enclosed, should be officially packaged with the necessary certificates and send by air cargo. Make sure that you comply with the aviation regulations.

2.5.3 Connection



WARNING

Do not use worn and/or damaged cables.

2.6 Environment and disposal of waste



CAUTION

Always observe the local rules and regulations with respect to processing or disposing of (non-reusable) parts.



CAUTION

Always first remove the battery. Refer to 5.4. For correct disposal of the battery, refer to 2.6.2.

2.6.1 Correct disposal of the product



WARNING

Do not dispose with other types of waste! This could possibly cause harm to the human health or the environment. If worn, damaged or not necessary anymore, please return the modem to your local dealer for correct disposal or repair.

2.6.2 Correct disposal of the battery



WARNING

Do not dispose with other types of waste! The battery contains substances that can cause harm to the human health or the environment.

To protect natural resources and promote material reuse, separate batteries from other types of waste and recycle them through your local battery return system.



CAUTION

Never return the DD-cell battery to the local dealer by air transport because the battery pack contains lithium.

3 Product overview

3.1 Outside view

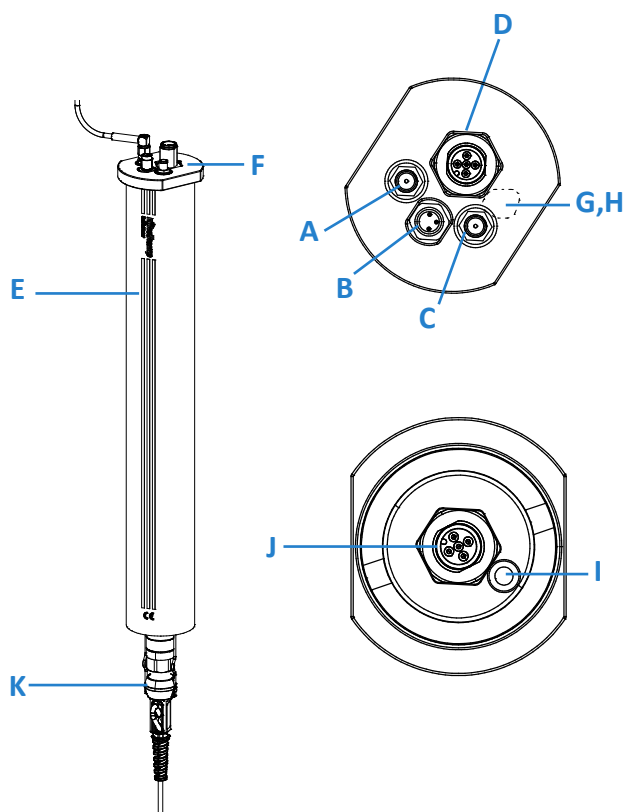

- A GPRS/UMTS antenna connector³
- B External power connector³ (3-pin male connector)
- C GPS antenna connector³
- D Multi sensor port³ (5-pin male connector, A-coded)
- E Enclosure
- F Top cap
- G Start switch (magnetically activated)
- H Connection / Error LED
- I Vent
- J Sensor port³ (5-pin male connector, A-coded)
- K Sensor cable



CAUTION

The modem has class IP68 protection (only with connected connectors). This means the modem is dust protected and resistant against temporary immersion. The temporary immersion must not exceed 50 hours, at a maximum of 2 meter under water. Do not continuously submerge in water. When there is water inside the enclosure, contact Eijkelkamp Soil & Water.

³ Including a protection cap

3.2 Inside view

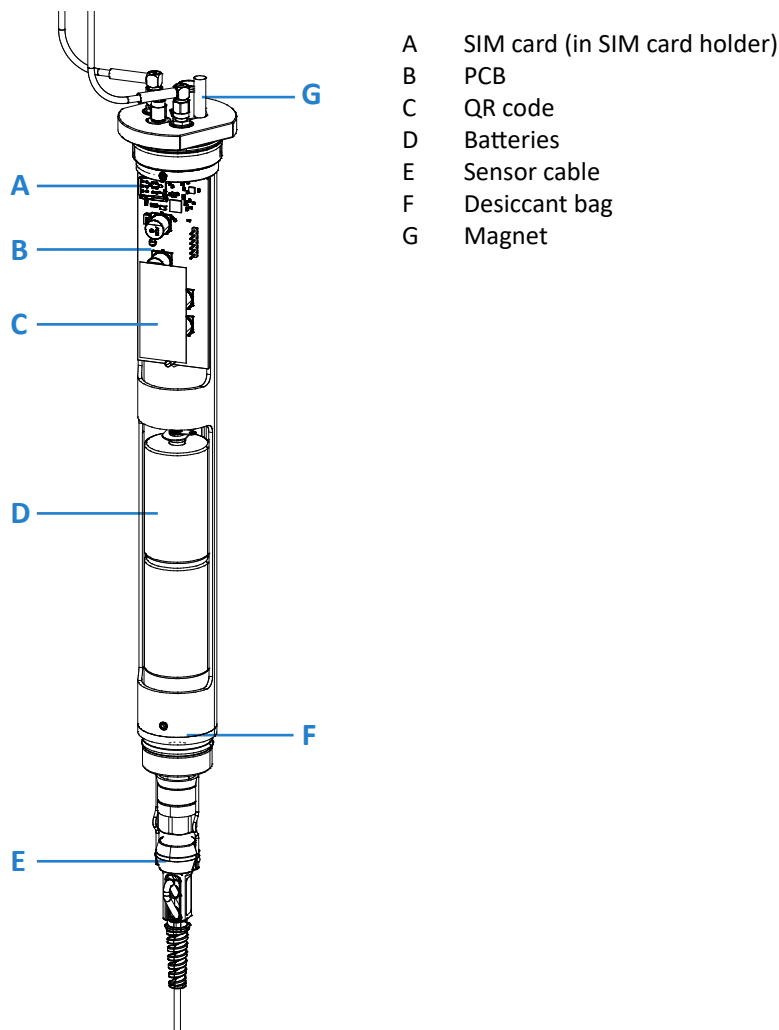

3.3 Explanation of the controls

The controls consist of a Start switch (magnetically activated) and multicolor LED (connection or error). Refer to 3.3.2 for the explanation of the LED. After the Start switch is magnetically activated, the LED shows the status of the modem after the connection has been established (or if it has failed). To save energy, the LED will be automatically disabled after about 15 seconds once a successful connection has been established, or after an error has occurred.



Note

The LED is always OFF until the Start switch is magnetically activated.



Note

When the batteries are inserted into the modem or the extended power is connected to the modem:

- The green and the red LED will go on simultaneously to indicate the modem is powered. Shortly after that the green LED will blink to indicate that the modem is establishing contact with the GDT-server.

3.3.1 Start switch

The Start switch (magnetically activated) is used to initially activate the modem and/or to initiate a connection to the GDT Server.

The Start switch is concealed in the top cap.

When the Start switch is magnetically activated :

- The green LED will blink.
- The modem starts to connect to the GDT Server.
- When the connection is established the green LED stays on approximately 15 seconds.

Note



It is not possible to deactivate the modem by magnetically activating the Start switch. Refer to 5.7.

3.3.2 Connection / Error LED (green / red)

The Connection LED shows the status of the connection with the GDT Server.

| | Description |
|------------------|---|
| Blinking (green) | The modem is busy connecting to the GDT Server |
| ON (green) | The modem is connected to the GDT Server |
| Blinking (red) | An error occurred |
| OFF | The modem is operating normally (active or in sleep mode) |

3.4 Technical data

3.4.1 Mechanical specifications

| Item | Specification |
|-----------------------------------|---|
| Housing dimensions | ∅ enclosure 48 mm, ∅ top cap 60 mm, length 340 mm |
| Weight (incl. alkaline batteries) | approx. 950 g |
| Enclosure material | Aluminium |
| Top cap material | Synthetic, POM (Polyoxymethylene) |

3.4.2 Electrical specifications

| Item | Specification |
|---|--|
| Battery internal | 2x D 1.5 V Alkaline / Life time depends on sensor type |
| Lithium battery (internal, for intensive use) | 3.6 V/35 Ah, Tadiran Lithium SL-2790S, size: DD |
| Modem clock accuracy | Better than 1 minute/day |

| External power supply | Specification |
|-----------------------|--|
| Voltage range | 6 - 14V DC |
| Power | 15W (min) and 25W (max) |
| Connector | M8, Female, 3-pin |
| Eijkelpamp options | Solar power kit (item 113426); Mounting set solar power (item 113427); External battery holder (item 113422) |

3.4.3 Connections

| Messaging | Specification |
|-------------------------------|------------------------------------|
| Message mode | web portal, e-mail, SMS alarms |
| Data encryption | AES (128 bits encryption) |
| GSM | GPRS (2.5 G) or UMTS (3 G) |
| SIM card | Multi-network SIM M2M* replaceable |
| Antenna connectors (external) | SMA connector |
| Sensor ports | 5-pin male M12 connector, A-coded |
| GNSS | Accuracy <2.5m CEP (open field) |
| External power supply | 3-pin Male M8 connector |

* SIM card exchangeable by the user. The functionality of SIM cards other than Multi-network SIM M2M is guaranteed only after the functionality tests are fulfilled by Eijkelpamp Soil & Water. Therefore it is advised to use tested SIM cards only.

| Antenna (Blue) | Specification |
|-------------------------|---|
| GPRS (external) (2.5 G) | Quad band type (850, 900, 1800, 1900 MHz) |
| UMTS (optional) (3 G) | Five band (800,850,900,1900,2100 MHz) |
| Connector | SMA Bulkhead |

| Antenna (Red) | Specification |
|-----------------|---------------|
| GNSS (external) | GPS, GLONASS |
| Connector | SMA Bulkhead |

| Sensor ports | Specification |
|------------------------|---|
| Number of sensor ports | 2 |
| Port 1 (bottom) | Diver or e+ logger via sensor cable |
| Port 2 (top cap) | Aquaread AP probe, SDI-12 sensor, analogue sensor, pulse counter, Diver, e+ logger via sensor cable |

| Port 2 (top cap) | Specification |
|------------------|--|
| Analogue in | DC: 0-5 V single ended or differential, 0-1 V single ended or differential, 0-20 mA, 4-20 mA |
| Data line | RX/TX (SDI-12, Aquaread, e+) |
| Power for sensor | DC 5 or 12 V, max. 500 mA continuous at 12 V |
| Memory | Aquaread AP probe: 18,724 records of time stamp SDI-12 sensor: 9,362 records of time stamp (with 9 channels) Analogue sensor: 87,379 records of time stamp |

| Integrated barometer sensor | Specification |
|-----------------------------|---|
| Barometer measuring range | 10 ... 1200 mbar * |
| Resolution | 0.01 mbar |
| Accuracy barometer | ± 2 mbar (at 300 ... 1100 mbar, 0 ... 50 °C) |
| Temperature measuring range | -40 ... +85 °C |
| Resolution | 0.01 °C |
| Accuracy temperature | ± 0.8 °C (at 25 °C) ± 2.0 °C (0 ... 50 °C) |
| Memory | 2,048 records of time stamp |

* 1 mbar is approximately 1 cmH₂O

3.4.4 Ambient conditions

| Item | Specification |
|-----------------------------------|------------------------------------|
| Temperature | -20 ... +60 °C |
| Ingression protection (enclosure) | IP68 (50 hours@2mH ₂ O) |

3.4.5 Certifications

| Item | Specification |
|-----------|--------------------------------------|
| CE | CE compliant |
| EMC / ESD | EN 61000-6-2:2005; EN 61000-6-4:2007 |

4 Getting started

4.1 Unpacking

1. When unpacking, carefully follow the instructions as given on the packaging or on the product.
2. Check that your delivery is correct and complete. Refer to the order list and the delivery list. If incomplete, contact Eijkelkamp Soil & Water.



CAUTION

Depending on the order, the modem is pre-installed with SIM card. Avoid unnecessary opening of the modem because of the risk of leakage.

3. Check the delivery for any transport damage. Report any damage immediately by filing a claim against the carrier and mark the bill of lading accordingly.

4.2 Providing power for the modem and/or sensor

The modem needs to be fitted with batteries, refer to 5.4 for placing them.

Depending on the type of sensor connected on the sensor port 2 (top cap) it might be preferred to also provide external power. Therefore it is possible to connect a larger external battery or power supply.



Note

Please refer to Electrical specifications (3.4.2) for requirements of external power supply. Eijkelkamp Soil & Water provides a power supply cable to be used with the modem (art.no.: 113421).



Note

Eijkelkamp Soil & Water provides 2 solutions for external power supplies:

1. Solar power kit (art.no.: 113426).
2. Battery holder (art.no.: 113422).

4.3 Setting up first-time communication

A new modem needs to be setup for customer use. This must be done by scanning the QR-code placed inside the modem. In the web page that opens the initial settings for a specific modem can be changed.



Note

When you make changes use “Apply” to activate the new setup

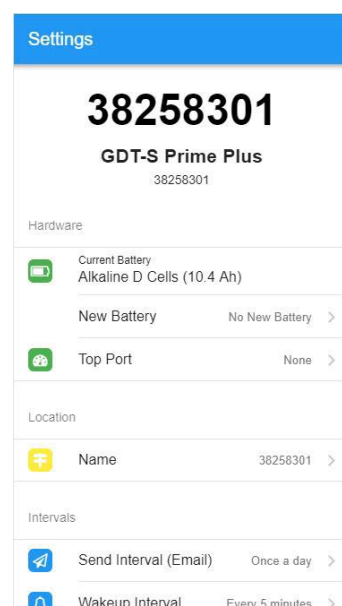
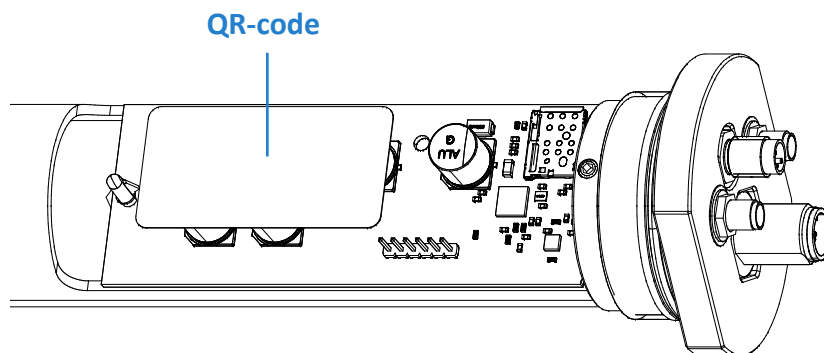

4.3.1 Placing internal battery

When placing batteries inside the modem you have to select the battery type you are using. There will also be a warning concerning the settings of the Top Port settings.



Note
This is only applicable for the internal batteries.



CAUTION
Anytime the modem power supply is switched on (by placing internal batteries and/or connecting the external power) the settings of the Top Port need to be confirmed or changed.

4.3.2 Select top port sensor

When using the top port sensor make sure you set up for the correct sensor. Setting up top port sensor by selecting "Top Port".

There are several pre-configured sensors to be selected.

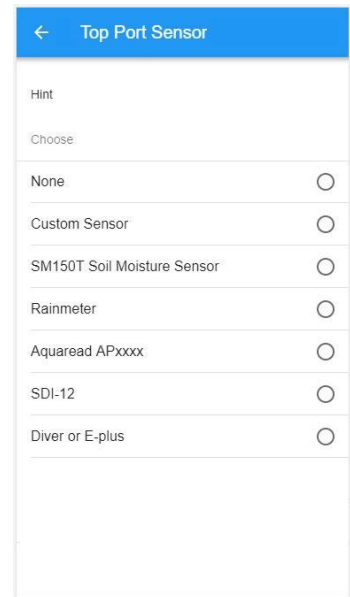
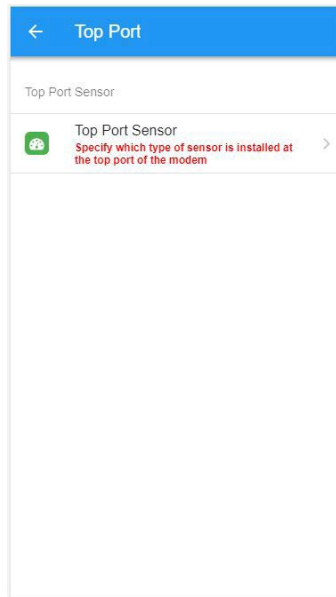
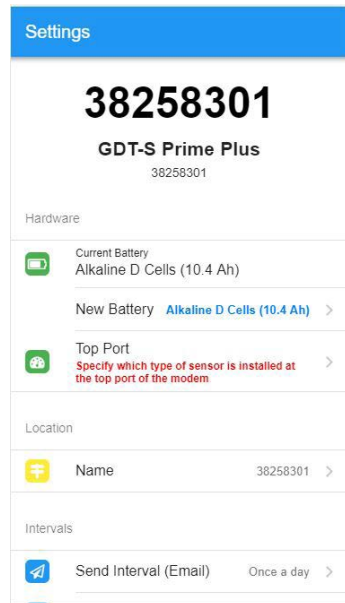
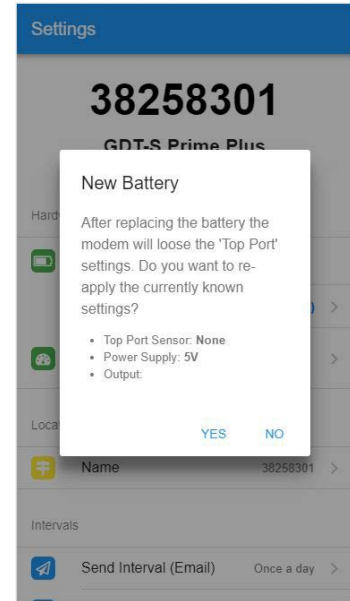
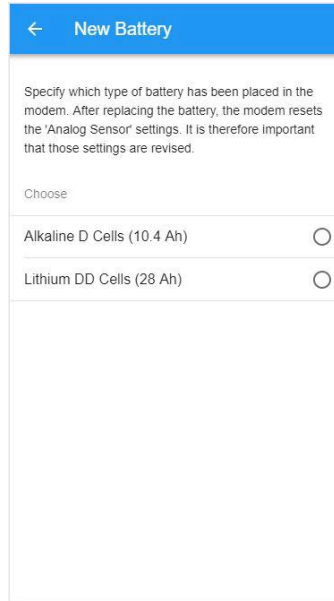

In this example we selected the SM150T Soil Moisture Sensor.

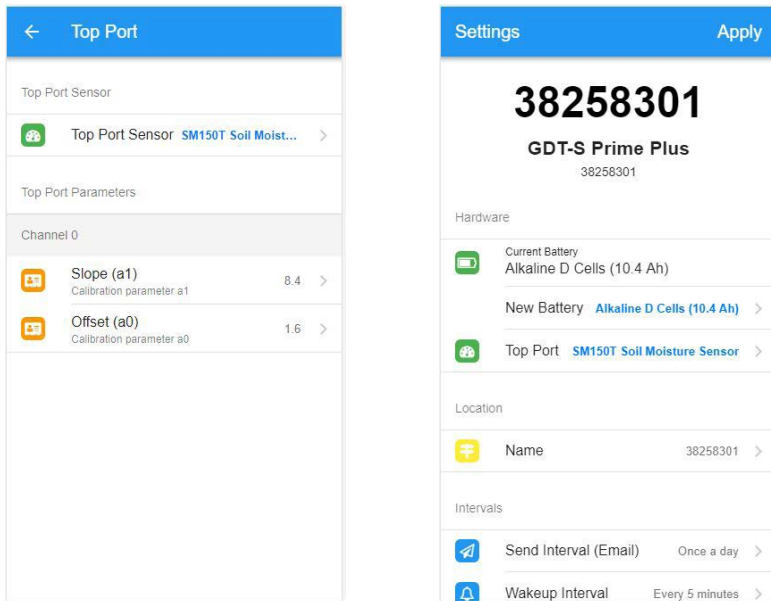

After the selection it is possible to adjust different parameters of this sensor so it can be configured for use.

If the sensor you want is not in the list, you can select “Custom Sensor” and check if it conforms to one of the basic interfaces as shown.

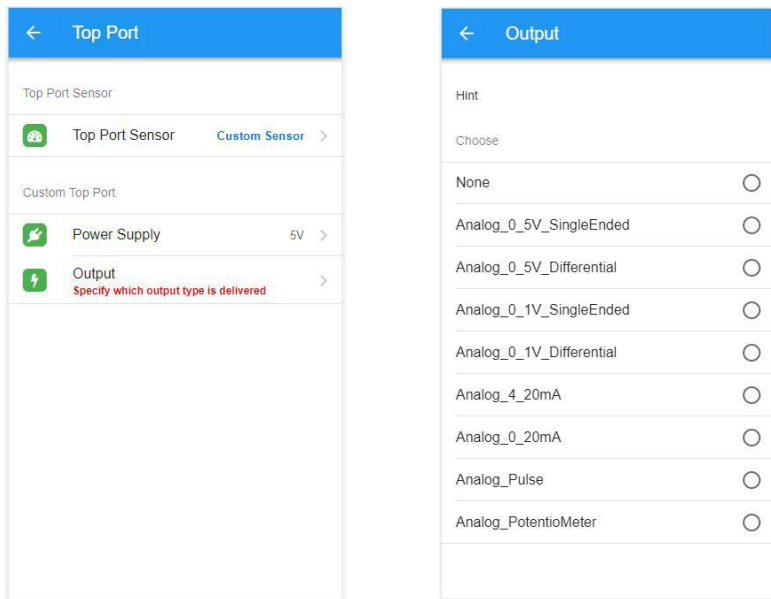

Note

If your sensor is not in the list, and you want to have it added, contact Eijkelkamp Soil & Water.

4.3.3 Location

If desired, change the location name.

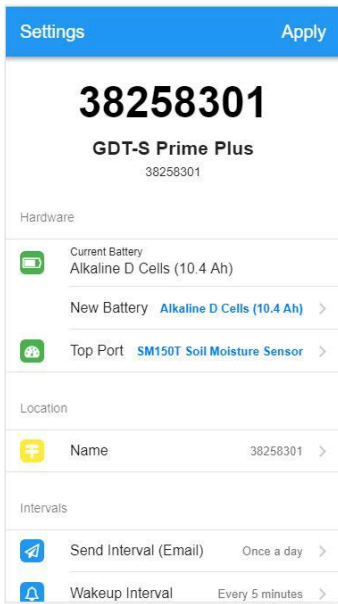

4.3.4 Intervals

Change intervals into the desired times.

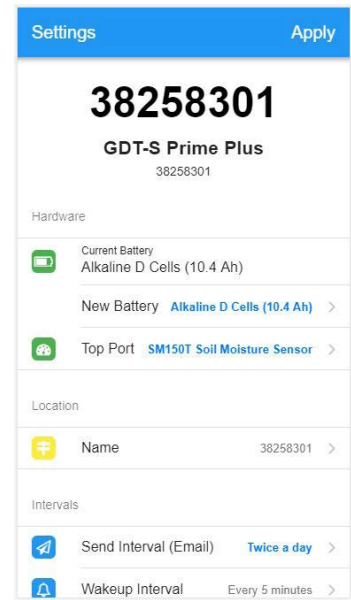
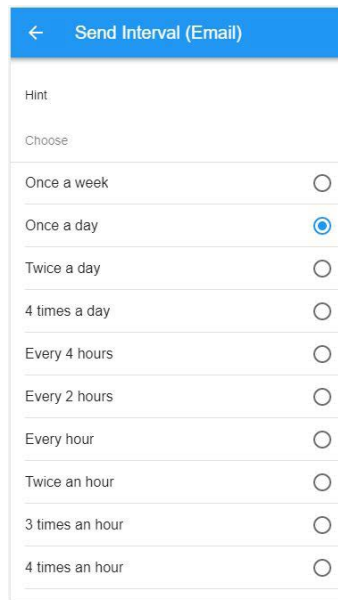
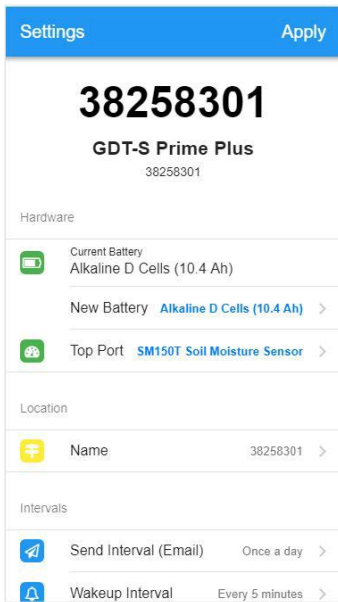

4.3.5 Setting up internal compensation

When using a Diver the data can be compensated with the internal Baro sensor of the modem by switching “Internal Compensation” on.

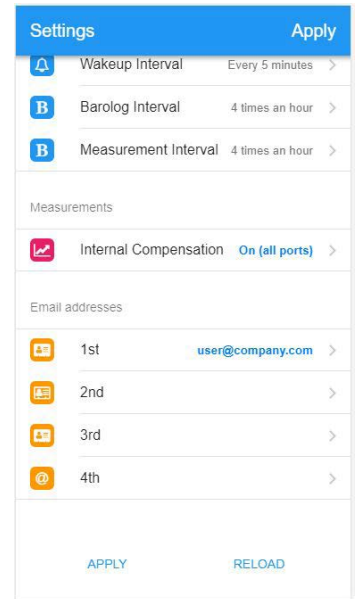
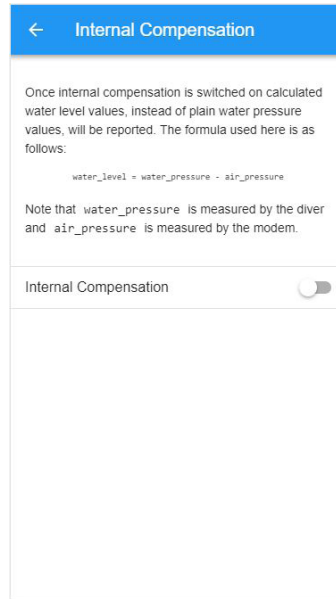
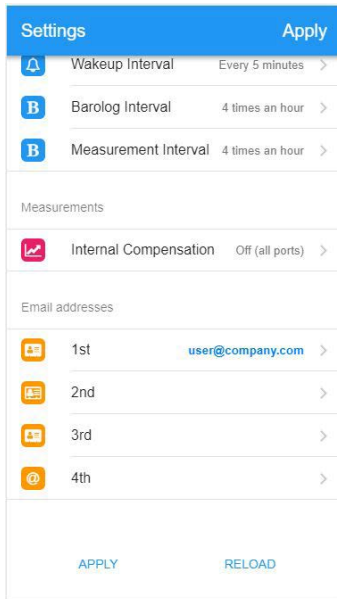

4.3.6 E-mail addresses

If you would like the modem to send you e-mails containing measurements data and settings. Enter e-mail address here.

Note
Default: There is no address filled in.

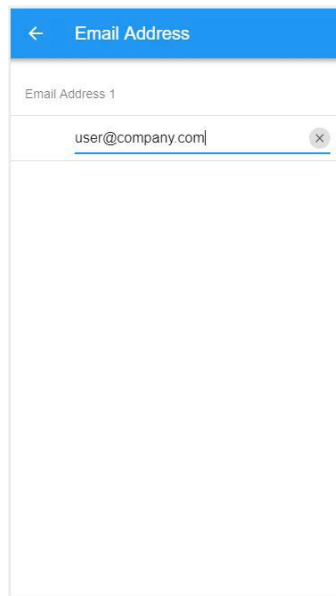
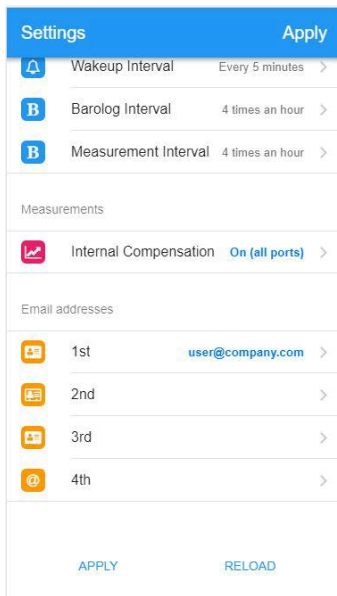

4.4 Installation



CAUTION

The guarantee will be void when the modem is not used for its intended use and/or at incorrect installation. Refer to 2.2 and 2.4.

4.4.1 Mounting the modem



CAUTION

- Place the modem in a protective environment.⁴
- Do not expose the modem to direct sunlight.
- Avoid deformation of the enclosure.
 - Do not use too much force when mounting the modem.
- The connector should be easily reachable and there should be enough space to connect the cable to the connector.
- All parts must be clean and dry prior to installation.
- Do not expose the modem to vibration, direct heat sources and/or forms of radiation and magnetism.

We distinguish two installation methods, namely;

1. Directly in the monitoring well, e.g. finished with a street cover (A) or
2. In a monitoring well that is installed in a well cover (B)

The modem is fitted with a GPRS/UMTS/GNSS antenna GDT-S Prime (art. no.: 113435).

The external antenna is intended to be installed on the cover of the well cover or with the mounting plate (C) in the street cover.

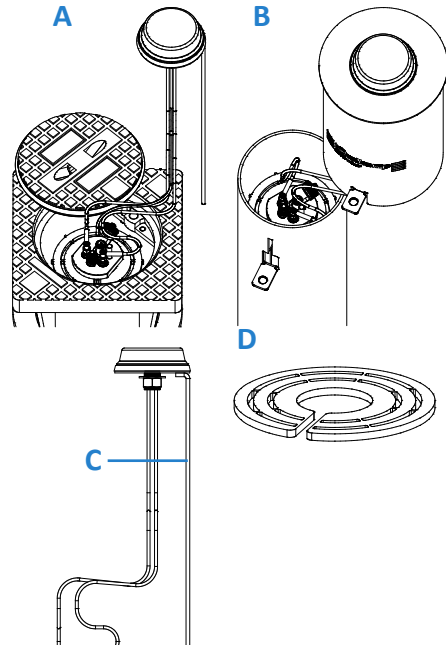

Adjust the universal monitoring well adapter ring (D) to your monitoring well in such a way that the modem hangs correctly in the monitoring well. Then connect the sensor cable to the modem. Install sensor, sensor cable and modem into the well cover.

4. If the protective environment is air-tight, the internal barometer data cannot be used. In this case, use the data of another barometer location or external Baro sensor.

4.4.2 Connecting the sensor cable bottom connector



CAUTION
All parts must be clean and dry prior to installation.



CAUTION
Do not use force. There is only one way to connect the cable to the sensor port. Always check the position of the positioning cam (B).

1. Slide the safety cord (C) over the sensor connector (D).
2. Install the sensor cable connector, pay attention to the positioning cam (B).
3. Fasten the sensor cable by turning the locking ring clockwise.



CAUTION
Do not fasten the cable too tight onto the connector. Use your thumb and index finger. For an internally clean connector, the IP68 protection class is guaranteed at a torque of 0.6 Nm.

4. Click the safety cord in the safety ring (E).

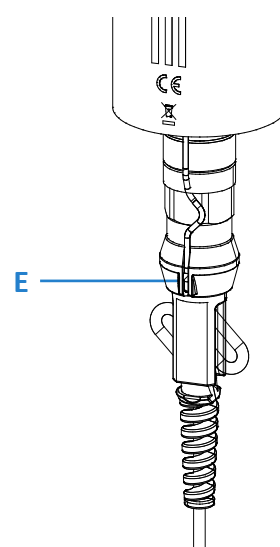
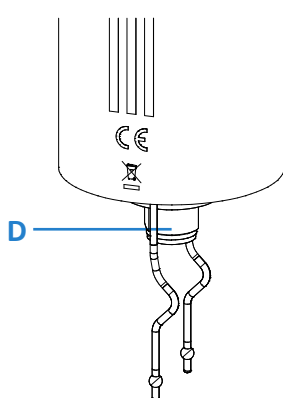
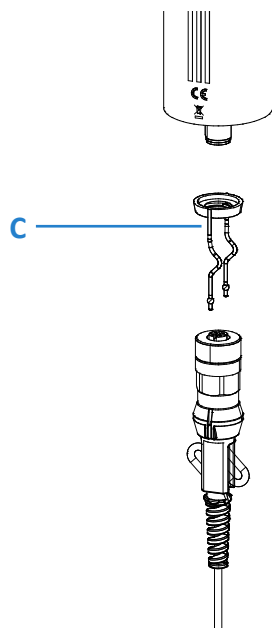
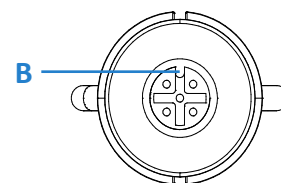
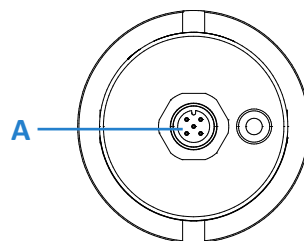

4.4.3 Connecting the external power connector



CAUTION
All parts must be clean and dry prior to installation.



CAUTION
Do not use force. There is only one way to connect the cable to the power port. Always check the position.

1. Install the power cable connector, pay attention to the positioning.
2. Fasten the power cable by turning the locking ring clockwise.



CAUTION
Do not fasten the cable too tight onto the connector. Use your thumb and index finger. For an internally clean connector, the IP68 protection class is guaranteed at a torque of 0.4 Nm.

4.4.4 Connecting the antenna



CAUTION
All parts must be clean and dry prior to installation.

1. Mount the antenna.
2. Screw the SMA connector onto the modem.
Do not use more torque than 5 lbs/0.57 Nm.



CAUTION
Do not use force.



CAUTION
Connect the GPS labeled connector to the red labeled connector.

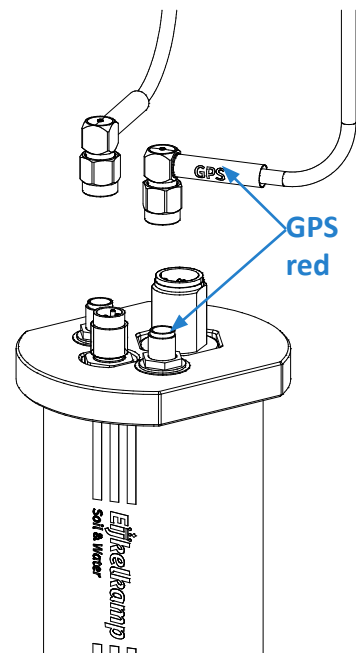
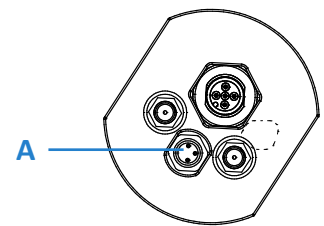

4.4.5 Connecting the sensor cable top connector



CAUTION
All parts must be clean and dry prior to installation.



CAUTION
Do not use force. There is only one way to connect the cable to the sensor port. Always check the position of the positioning cam (B).

1. Install the sensor cable connector, pay attention to the positioning cam (B).
2. Fasten the sensor cable by turning the locking ring clockwise.



CAUTION
Do not fasten the cable too tight onto the connector. Use your thumb and index finger. For an internally clean connector, the IP68 protection class is guaranteed at a torque of 0.6 Nm.

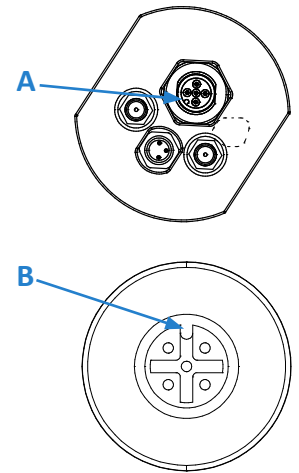

4.5 Commissioning

- A Connection / Error LED (green/red)
- B Start switch
- C Magnet

1. Activate the Start switch by moving a magnet (C) close to position B on top of the modem. The connection LED (A) will start blinking green..

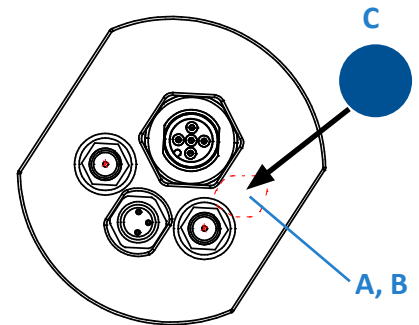

Note
The LED should blink green. Refer to 3.3 to see which status the LED indicates.

2. The GDT Server will activate the connected sensors.
3. If commissioning is OK the green LED goes off after 15 seconds.



Note
If the LED should blink red, follow the steps from the table below.

| Option | Specific action |
|--------|--|
| 1 | Retry the activation with the Start switch |
| 2 | Reposition the antenna, for example higher up |
| 3 | Check if the SIM card is correctly installed |
| 4 | Check with the network provider if the connection still works correctly |
| 5 | If none of the above solves the problem, contact Eijkelkamp Soil & Water |

4.6 Connector configuration top port

Connect the sensor to the modem with the M12 connector.



Note
Consult appropriate sensor manual for wire functions and colors.

Connecting an Aquaread AP probe.

| M12 pin number | Function | Range |
|----------------|-------------------|---------|
| 1 | Aqua RX | |
| 2 | Aqua TX | |
| 3 | GND | |
| 4 | | |
| 5 | Voltage supply V+ | 12 V DC |

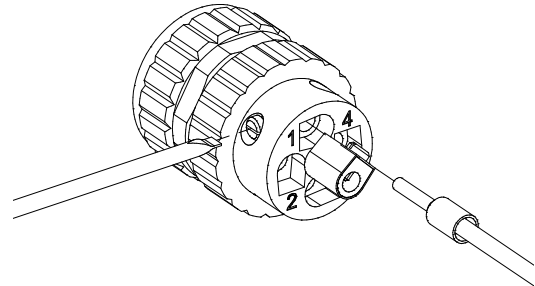

Connecting a SDI-12 sensor.

| M12 pin number | Function | Range |
|----------------|-------------------|---------|
| 1 | SDI-12 RX_TX | |
| 2 | | |
| 3 | GND | |
| 4 | | |
| 5 | Voltage supply V+ | 12 V DC |

Connecting a single ended voltage sensor.

| M12 pin number | Function | Range |
|----------------|-------------------|-------------------|
| 1 | ANA IN1+ | 0...2 V DC |
| 2 | ANA IN2+ | 0...5 V DC |
| 3 | GND | |
| 4 | ANA IN3+ | 0...5 V DC |
| 5 | Voltage supply V+ | 5 V DC or 12 V DC |

Connecting a differential voltage sensor 0-1 V.

| M12 pin number | Function | Range |
|----------------|-------------------|-------------------|
| 1 | | |
| 2 | ANA IN1+ | |
| 3 | GND | |
| 4 | ANA IN1- | |
| 5 | Voltage supply V+ | 5 V DC or 12 V DC |

Connecting a differential voltage sensor 0-5 V.

| M12 pin number | Function | Range |
|----------------|-------------------|-------------------|
| 1 | | |
| 2 | ANA IN1+ | |
| 3 | GND | |
| 4 | ANA IN1- | |
| 5 | Voltage supply V+ | 5 V DC or 12 V DC |

Connecting a rain gauge / count channel.

| M12 pin number | Function | Range | |
|----------------|----------|-------|---|
| 1 | Pulse IN | | Short-circuit with V+ to obtain a pulse |
| 2 | | | |
| 3 | GND | | |
| 4 | | | |
| 5 | | | |

Connecting a 2-wire current sensor.

| M12 pin number | Function | Range |
|----------------|-------------------|------------------------|
| 1 | IN+ | 0...20 mA or 4...20 mA |
| 2 | | |
| 3 | GND | |
| 4 | | |
| 5 | Voltage supply V+ | 5 V DC or 12 V DC |

Connecting Diver or e+ logger use the GDT 1-eye sensor cable or GDT 2-eye sensor cable.
Or if there is room enough above the modem connect a MDC 1-eye or 2-eye cable.

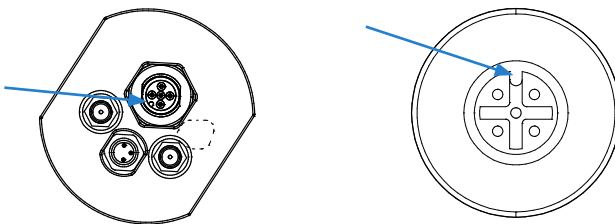

Note

Before closing the M12 connector pay attention to the positioning cam.
Make sure the cable is not interfering with the other connectors on top of the modem.

5 Maintenance

5.1 Preparation



CAUTION

Only original parts must be used, otherwise the guarantee will be void.

Make sure you take with you the following tools and accessories:

- Cloth (clean, dry and lint-free);
- Replacement desiccant kit. Refer to 6.1.
- Replacement battery. Refer to 6.1.
- Replacement SIM card (optional).
- Replacement antenna.
- Replacement cable and sensor.

5.2 General inspection overview

The modem requires little maintenance. However, if you need to do maintenance work, always check the following points during maintenance.

| Inspection | Check | Action (if required) |
|----------------------|-----------------|--|
| Enclosure (external) | Dirt / Humidity | Clean and dry with a dry, lint-free cloth |
| Enclosure (internal) | Humidity | Replace the desiccant kit. Refer to 5.3.5. If wet or moisty, contact Eijkelkamp Soil & Water. |
| Sensor cable | Wear or damage | Replace the cable |
| Antenna | Wear or damage | Replace the antenna |
| Power cable | Wear or damage | Replace the cable |
| SIM card | | Refer to 5.5 |



Note

It is advised always to take replacement batteries with you. Check the battery capacity level beforehand via the Eijkelkamp Web Portal or the e-mail functionality. Refer to the Online Manual or to Supplement 2 on how to check the battery capacity level. This will only be true when there is no external power supplied.



Note

Never take a lithium battery or a modem with an installed lithium battery with you as luggage during a flight. Due to severe civil aviation regulations (class 9 dangerous goods), it is forbidden to take a lithium battery with you during a flight.

5.3 Inspection and cleaning



We advise you to take the necessary ESD safety regulations for the modem during assembly (when the o-rings are damaged, contact Eijkelkamp Soil & Water).

5.3.1 Inspecting and cleaning the outside of the modem

1. Check the outside of the modem for dirt and humidity. Pay special attention to the vent. The vent has to be free of dirt. Never use sharp tools to clean.
2. Clean and dry the modem with a dry, lint-free cloth.

5.3.2 Dismounting the modem



Note

If you need to open the enclosure, it is advised to remove the modem from the measuring site, so the modem can be taken to a clean and dry environment.

1. Check if the cable and connectors are still connected correctly. Also check the cable and connectors for possible defects.
2. Disconnect the antenna from the antenna connectors. Turn the hexagon locking counter clockwise.
3. Disconnect the sensor cable from the sensor port. Turn the hexagon locking counter clockwise.
4. Disconnect the power cable from the power connector. Turn the hexagon locking counter clockwise.
5. Clean the antenna connectors and sensor port with a dry, lint-free cloth.
6. Take the modem to a clean and dry environment.

5.3.3 Opening the enclosure



CAUTION

Do not open the modem in the field. Only open the modem in a clean and dry environment.



Note

It is advised not to open the enclosure unless it is really necessary (e.g. for placing / replacing the batteries). Opening the enclosure increases the risk of leakage afterwards.

1. Turn the housing counter clockwise and **carefully** remove the slider out of the housing.

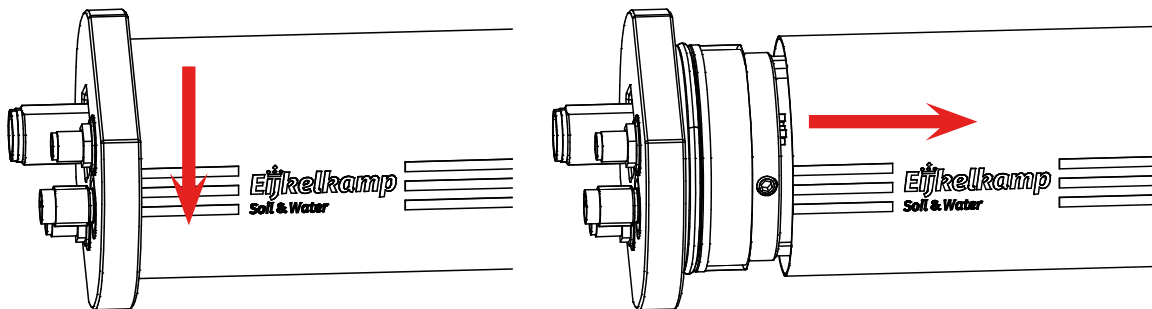

5.3.4 Inspecting and cleaning the inside of the modem

1. Check the inside of the modem for dirt, dust, humidity and damage. Pay special attention to the sealings of the slider top cap and the bottom cap, the sealing rings must be free of dirt, undamaged and not-twisted.



WARNING

The modem must be free from dirt, dust, humidity and damage. Only clean the seal and flash ridge with a clean lint-free cloth if necessary. Never touch the electronics of the printed circuit board (PCB)!



CAUTION

Do not use greasy substances and agents, such as white spirit, acetone or thinner.

5.3.5 Replacing the desiccant bag



CAUTION

Only use original parts. A new desiccant kit can be ordered at Eijkelkamp Soil & Water. Refer to 6.1.



CAUTION

Work only in a dry environment, try to act quickly during the replacing of the desiccant bag!

1. Remove the old desiccant bag carefully and check whether this bag is excessively wet. If this is the case, this could be an indication of leakage. Please contact Eijkelkamp Soil & Water service department.



CAUTION

The new desiccant bag (A) must be taken out of its package at the last moment. It must be protected against all kinds of moisture before it is placed in the dry enclosure of the modem.

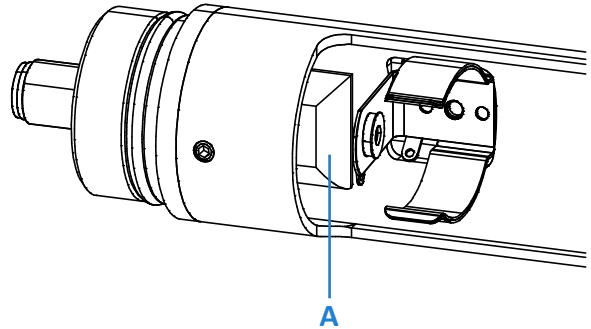

2. Carefully place the new desiccant bag into the same place as the old one.
3. If it is not necessary to replace the battery, close the enclosure immediately. See 5.3.6.

5.3.6 Closing the enclosure

1. Check whether the O-rings (A) are clean and undamaged.
2. Check whether the top cap and the bottom cap with the O-rings is dirt-free, along with the sealing surfaces (B) in the housing tube.
3. If the O-rings are black and no grease is visible on the surface, apply a thin layer of acid-free vaseline (prevent dirt, work clean)
4. Carefully slide the modem back into the housing tube and turn the slider into the housing with a turning movement completely to the top cap.

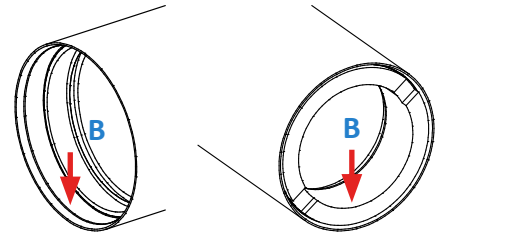
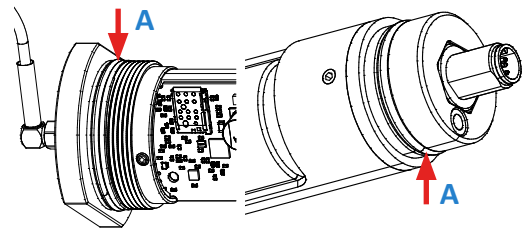

5.3.7 Mounting the modem

1. Connect the antenna to the antenna connectors. Refer to 4.4.4.
2. Connect the sensor cable to the sensor port. Refer to 4.4.2 and 4.4.5.
3. Connect the power cable (if used). Refer to 4.4.3
3. Re-install the modem in the monitoring well or well cover.
4. Start the commissioning process. Refer to 4.5.

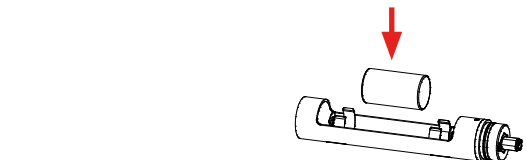

5.4 (Re-)placing the battery

On receipt of a 'low battery' alarm, the battery must be replaced along with the desiccant bag.



We advise you to take the necessary ESD safety regulations and to apply new acid-free vaseline to the O-rings of the modem during assembly.



Note
When O-rings are damaged contact Eijkelkamp Soil & Water.



Note
Use original or recommended parts. Refer to 6.1.

1. Follow all procedures of 5.3.1 to 5.3.5.



CAUTION

Work according to your local ESD safety regulations. Avoid touching the printed circuit board (PCB).

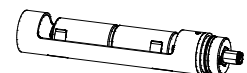
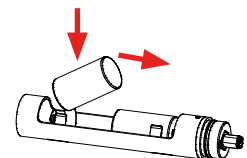
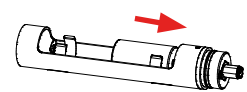



Note

All setting changes that have not yet been saved will be lost when the battery is disconnected.

- Carefully remove the empty battery.
- Place the replacement battery pack.



CAUTION

Prevent damage to the battery.



Note

Make sure the battery is placed in the correct position.



Note

When the battery is inserted into the modem:

- The LED will briefly go on to indicate the modem is powered
- The modem will behave as if the Start switch was magnetically activated
- When this is not the case, check if the contacts from the battery holder are correctly placed to the contacts of the battery.
- If necessary take out the battery and carefully bend the contacts and place the battery once again.

- Use the QR instruction 4.3 to set the new batteries and reconfirm the top port sensor configuration.



Note

When placing two D cell alkaline batteries change to/check if the battery capacity max (μAh) is 10400000 μAh.
When placing a DD cell lithium battery change to/check if the battery capacity max (μAh) is 28000000 μAh.

- Follow all procedures of 5.3.6 to 5.3.7.
- Dispose of the old battery in a proper way. Refer to 2.6.2.

5.5 (Re-)placing the SIM card (optional)



WARNING

Depending on the new SIM card the modem settings may need to be changed, therefore always contact Eijkelkamp Soil & Water first.



WARNING

Always disconnect the battery before replacing the SIM card.



CAUTION

Make sure that the PIN code of the SIM card is turned off or set to the desired PIN code.



Note

If a PIN code is used, make sure that the PIN code that was configured in the modem is identical to the PIN code of the SIM card.

- Follow all procedures of 5.3.1 to 5.3.5.
- Remove the battery. Refer to 5.4
- Push onto the SIM. Refer to step 1 in the figure.
- Remove the SIM card from the holder. Refer to step 2 in the figure.
- Place the new SIM card into the holder. Refer to step 4 and 5 in the figure.
- Place the battery. Refer to 5.4.
- Follow all procedures of 5.3.6 to 5.3.7.

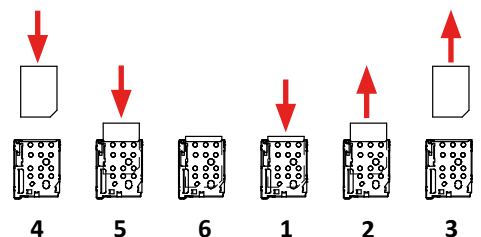

5.6 (Re)placing sensor(s)

When you have to change the sensor(s) connected to the modem you need to change the setup of the Modem. (This is only applicable if using the Eijkelkamp Web Portal).

1. Disconnect the modem. Refer to 5.3.2.
2. Remove the internal batteries. Refer to 5.4.
3. Use the QR instruction 4.3 for changing the modem configuration.
4. Press “Apply” to activate new setup.
5. Place the internal batteries. Refer to 5.4.
6. Connect the modem. Refer to 5.3.7.

5.7 Storage



CAUTION

Do not place the modem in a humid and dusty environment. Do not place any heavy materials on top of the modem.

1. Clean the outside of the modem. Refer to 5.3.1.
2. Dismount the modem. Refer to 5.3.2.
3. Store the modem in a clean and dry place.



Note

If a modem is not to be used for a longer period of time, it is important that the modem will be set in the power OFF mode via the Eijkelkamp Web Portal or e-mail functionality. Refer to the online manual on Eijkelkamp Web Portal or Supplement 2 on how to put the modem in the power OFF mode. In case the modem will not be used for a very long period of time, it is also advised to disconnect the battery. Even if the modem is in the power OFF mode, it actually continues to draw a minimum amount of current and thus drains the battery. However, it is also advised not to open the enclosure of the modem unless you really need to do so. Opening the enclosure increases the risk of leakage afterwards. Consider whether the battery needs to be removed or not. If the battery needs to be removed, refer to step 1 and 2 of 5.4.

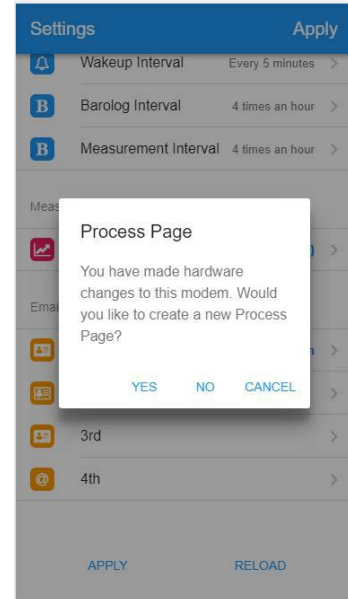

6 Specifications

6.1 Parts list



CAUTION

Only original parts must be used, otherwise the guarantee will be void (except Battery D).

| Article number | Part name |
|----------------|--|
| 113403 | Global Data Transmitter Single Prime Plus (GDT-S Prime Plus) GPRS |
| 113404 | Global Data Transmitter Single Prime Plus UMTS |
| 113405 | Global Data Transmitter Single Prime Plus OEM GPRS |
| 113406 | Global Data Transmitter Single Prime Plus OEM UMTS |
| 113121 | Battery (D, LR20, MX1300), 1.5 Volt, alkaline, low in mercury and cadmium free, blister pack of 2 pieces (or similar). |
| 113420 | Battery for GDT-S Prime, 3.6 V / 35 Ah, Tadiran Lithium SL-2790S, size: DD |
| 113422 | Battery holder GDT-S Prime Plus |
| 113435 | GPRS / UMTS / GNSS antenna for GDT-S Prime Plus |
| | |
| 113421 | Cable for external power supply |
| 113422 | External battery holder |
| 113426 | Solar power kit |
| 113427 | Mounting set for solar power |
| | |
| 11313401 | Antenna mounting plate |
| 113135 | Adaptor ring GDT-S |
| H276414 | Dessicant bag 5 gr. |

7 Declaration of Conformity

7.1 EC Declaration GPRS



EC Declaration of Conformity*

The undersigned, representing the manufacturer:

Eijkelkamp Soil & Water BV
Nijverheidsstraat 30
6987 EM Giesbeek The Netherlands

Herewith declare that the product:

Type: Global Data Transmitter Single Prime Plus (GPRS; Quad-Band 2,5G)
Art.nr.: 113403
Function(s): connecting element between sensor(s) and the GDT Server in the Eijkelkamp Smart Sensoring.
The most important functions of the modem:
- Passing through the collected data of the connected sensor(s) to the GDT Server;
- Enabling remote monitoring of the connected sensor(s).

is in conformity with the essential requirements of the following EC Directive(s) when installed in accordance with the installation instructions contained in the product documentation:

- a) 2014/30/EU EMC Directive
- b) 1999/5/EC R&TTE (applies only the module; Quectel M95)
- c) 2014/53/EU RE (applies only the module: Quectel L76)
- d) 2012/19/EU Waste Electrical and Electronic Equipment (WEEE)
- e) 2011/65/EU RoHS Directive



and that the standards and/or technical specifications referenced below have been applied:

- a) EMC-Directive:
 - EN 61000-6-2:2005/C11:2005 Electromagnetic compatibility (EMC) - Part 6-2: Generic standards - Immunity for industrial environments
 - EN 61000-6-4:2007/A1:2011 Electromagnetic compatibility (EMC) - Part 6-4: Generic standards - Emission standard for industrial environments
- b) R&TTE Directive: (applies only the GSM/GPRS module; Quectel M95)
 - EN 301 489-1 V1.9.2 Electromagnetic compatibility and Radio spectrum Matters (ERM); ElectroMagnetic Compatibility (EMC) standard for radio equipment and services; Part 1: Common technical requirements
 - EN 301 489-7 V1.3.1 Electromagnetic compatibility and Radio spectrum Matters (ERM); ElectroMagnetic Compatibility (EMC) standard for radio equipment and services; Part 7: Specific conditions for mobile and portable radio and ancillary equipment of digital cellular radio telecommunications systems (GSM and DCS)
 - EN 301 511 V9.0.2 Global System for Mobile communications (GSM); Harmonized EN for mobile stations in the GSM 900 and GSM 1800 bands covering essential requirements under article 3.2 of the R&TTE directive (1999/5/EC)
- c) RE Directive: (applies only the GPS/GNSS module; Quectel L76)
 - EN 301 489-1 V2.1.1 ElectroMagnetic Compatibility (EMC) standard for radio equipment and services; Part 1: Common technical requirements; Harmonised Standard covering the essential requirements of article 3.1(b) of Directive 2014/53/EU and the essential requirements of article 6 of Directive 2014/30/EU
 - EN 303 413 V1.1.0 (Draft) Satellite Earth Stations and Systems (SES); Global Navigation Satellite System (GNSS) receivers; Radio equipment operating in the 1 164 MHz to 1 300 MHz and 1 559 MHz to 1 610 MHz frequency bands; Harmonised Standard covering the essential requirements of article 3.2 of Directive 2014/53/EU

Giesbeek, 03-Juli-2018

Manufacturer:
Signature

Huug Eijkelkamp
CCO

7.2 EC Declaration UMTS



EC Declaration of Conformity*

The undersigned, representing the manufacturer:

Eijkelpoort Soil & Water BV
Nijverheidsstraat 30
6987 EM Giesbeek The Netherlands

Herewith declare that the product:

Type: Global Data Transmitter Single Prime Plus (UMTS; Five-Band 3G)
Art.nr.: 113404
Function(s): connecting element between sensor(s) and the GDT Server in the Eijkelpoort Smart Sensoring.
The most important functions of the modem:
- Passing through the collected data of the connected sensor(s) to the GDT Server;
- Enabling remote monitoring of the connected sensor(s).

is in conformity with the essential requirements of the following EC Directive(s) when installed in accordance with the installation instructions contained in the product documentation:

- a) 2014/30/EU EMC Directive
- b) 1999/5/EC R&TTE (applies only the UMTS/HSPA module; Quectel UG96)
- c) 2014/53/EU RE (applies only the module: Quectel L76)
- d) 2012/19/EU Waste Electrical and Electronic Equipment (WEEE)
- e) 2011/65/EU RoHS Directive



and that the standards and/or technical specifications referenced below have been applied:

- a) EMC-Directive:
 - EN 61000-6-2:2005/C11:2005 Electromagnetic compatibility (EMC) - Part 6-2: Generic standards - Immunity for industrial environments
 - EN 61000-6-4:2007/A1:2011 Electromagnetic compatibility (EMC) - Part 6-4: Generic standards - Emission standard for industrial environments
- b) R&TTE Directive: (applies only the UMTS/HSPA module; Quectel UG96)
 - EN 301 489-1 V1.9.2 Electromagnetic compatibility and Radio spectrum Matters (ERM); ElectroMagnetic Compatibility (EMC) standard for radio equipment and services; Part 1: Common technical requirements
 - EN 301 489-7 V1.3.1 Electromagnetic compatibility and Radio spectrum Matters (ERM); ElectroMagnetic Compatibility (EMC) standard for radio equipment and services; Part 7: Specific conditions for mobile and portable radio and ancillary equipment of digital cellular radio telecommunications systems (GSM and DCS)
 - EN 301 489-24 V1.5.1 Electromagnetic compatibility and Radio spectrum Matters (ERM); ElectroMagnetic Compatibility (EMC) standard for radio equipment and services; Part 24: Specific conditions for IMT-2000 CDMA Direct Spread (UTRA and E-UTRA) for Mobile and portable (UE) radio and ancillary equipment
 - EN 301 511 V9.0.2 Global System for Mobile communications (GSM); Harmonized EN for mobile stations in the GSM 900 and GSM 1800 bands covering essential requirements under article 3.2 of the R&TTE directive (1999/5/EC)
 - EN 301 908-1 V7.1.1 IMT cellular networks; Harmonized EN covering the essential requirements of article 3.2 of the R&TTE Directive; Part 1: Introduction and common requirements
 - EN 301 908-2 V6.2.1 IMT cellular networks; Harmonized EN covering the essential requirements of article 3.2 of the R&TTE Directive; Part 2: CDMA Direct Spread (UTRA FDD) User Equipment (UE)
- c) RE Directive: (applies only the GPS/GNSS module; Quectel L76)
 - EN 301 489-1 V2.1.1 ElectroMagnetic Compatibility (EMC) standard for radio equipment and services; Part 1: Common technical requirements; Harmonised Standard covering the essential requirements of article 3.1(b) of Directive 2014/53/EU and the essential requirements of article 6 of Directive 2014/30/EU
 - EN 303 413 V1.1.0 (Draft) Satellite Earth Stations and Systems (SES); Global Navigation Satellite System (GNSS) receivers; Radio equipment operating in the 1 164 MHz to 1 300 MHz and 1 559 MHz to 1 610 MHz frequency bands; Harmonised Standard covering the essential requirements of article 3.2 of Directive 2014/53/EU

Giesbeek, 03-Juli-2018

Manufacturer:
Signature

Huug Eijkelpoort
CCO